

Ficha datos envase · Data sheet container · Conteneur Fiche technique

REFERENCIA · REFERENCE · RÉFÉRENCE

3222

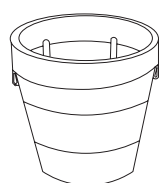

0108

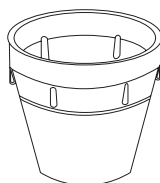

0110

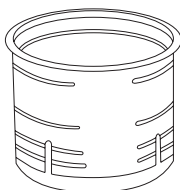

0446

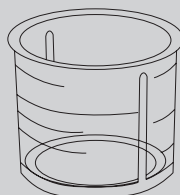

3222

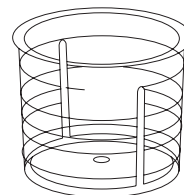

3233



3204



Número de referencia Reference number Numéro de référence	Capacidad (ml) Capacity (ml) Capacité (ml)	Diámetro superior Superior diameter Diamètre supérieure	Diámetro inferior Inferior diameter Diamètre inférieur	Altura (mm) Height (mm) Hauteur (mm)	Nivel de diámetro Level diameter Diamètre de niveau	Escala de graduación Scale graduation Echelle graduation
3222	15,00	33,90	30,30	30,41	28,00	1,00-2,50-5,00- 7,50-10,00-15,00

Dimensiones de la pieza · Part dimensions · Dimensions de la pièce

ref.
3222

Vasito fabricado en PP random para tapón PILFER 28
Cup made of PP random to plug PILFER 28
Coupe en PP aléatoire de brancher PILFER 28

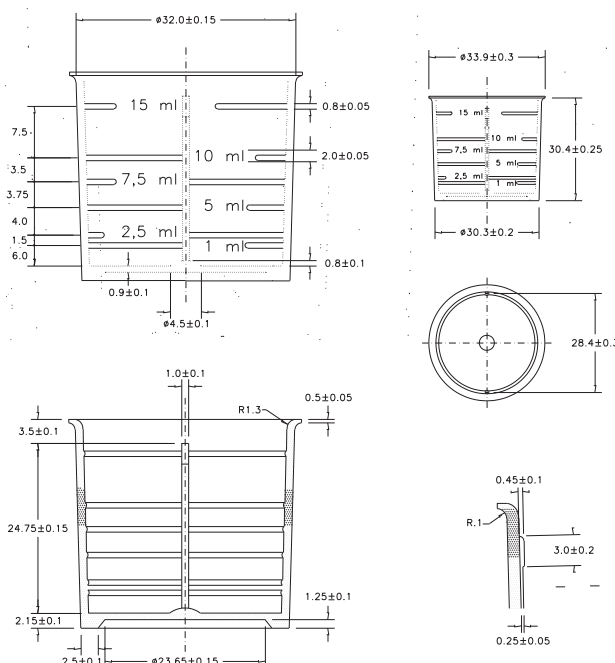
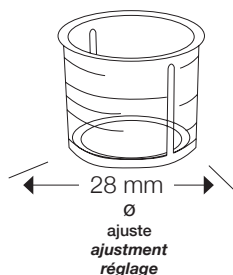

Indústrias Plásticas Triana, S.A.

Pol. Ind. Santiga t.: +34 93 719 11 67 f.: +34 93 719 05 29
C/ Can Magi, 12 www.ip triana.com
08210 Barberà del Vallès info@ip triana.com
Barcelona · Spain



ISO 9001/2015 ISO 13485